



## Free 4' x 6' Chicken Coop Plan

Up to 10 chickens



## Compare Free vs. Premium plan

	Free plan	Premium edition
Pages	17	24
Illustrations for Each Step	✓	✓
Print Ready	✓	✓
Step By Step Instructions	✓	✓
Full Materials and Cuttings List	✗	✓
Additional Illustrations	✗	✓
Additional Blueprints	✗	✓
Tools List	✗	✓
Fastening Elements List	✗	✓
Technical Support	✗	✓

[TRY PREMIUM](#)



# Size & Dimensions

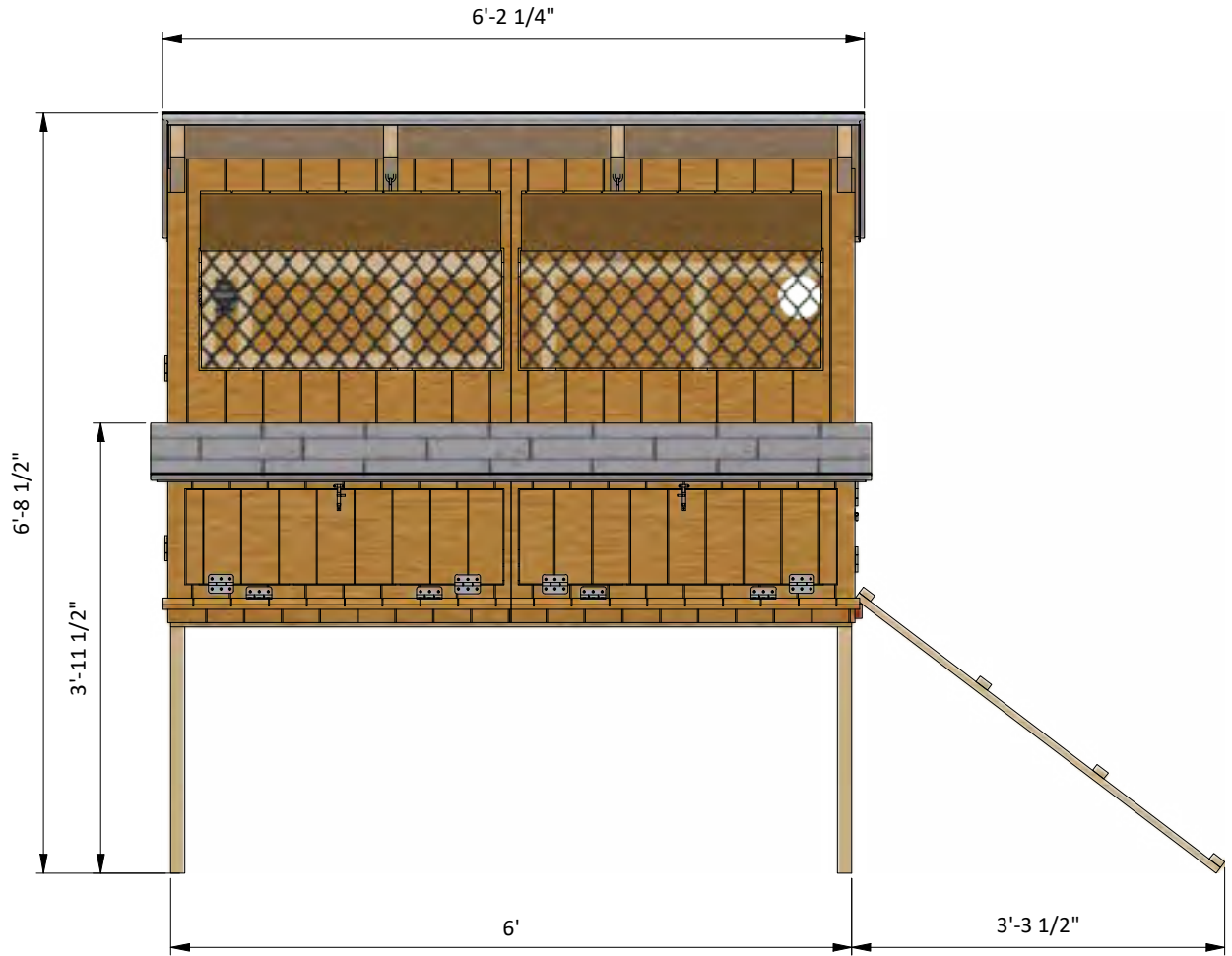

Roof pitch  $\triangle 2/12$

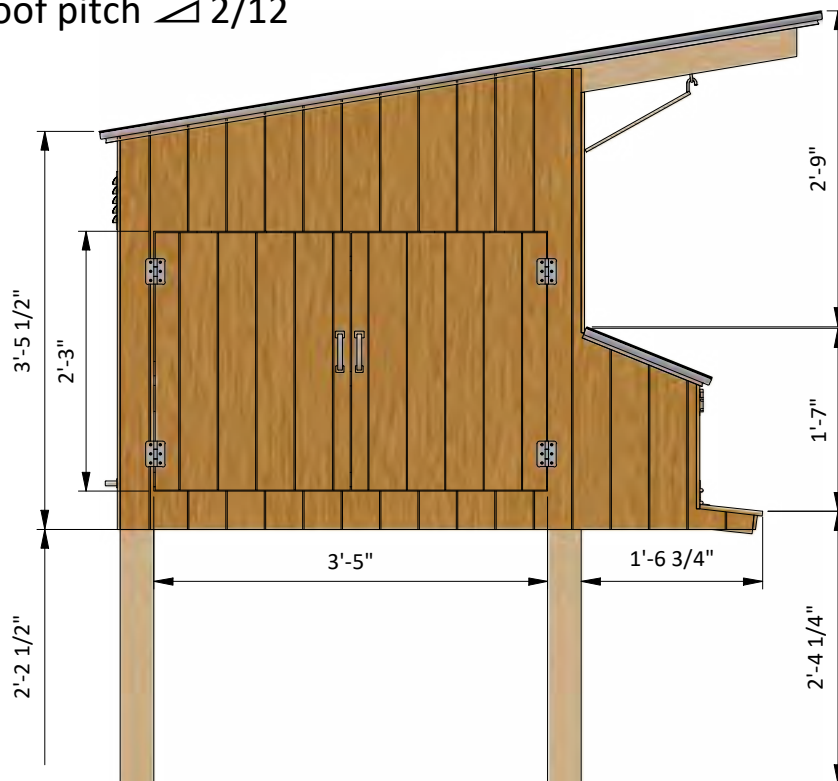

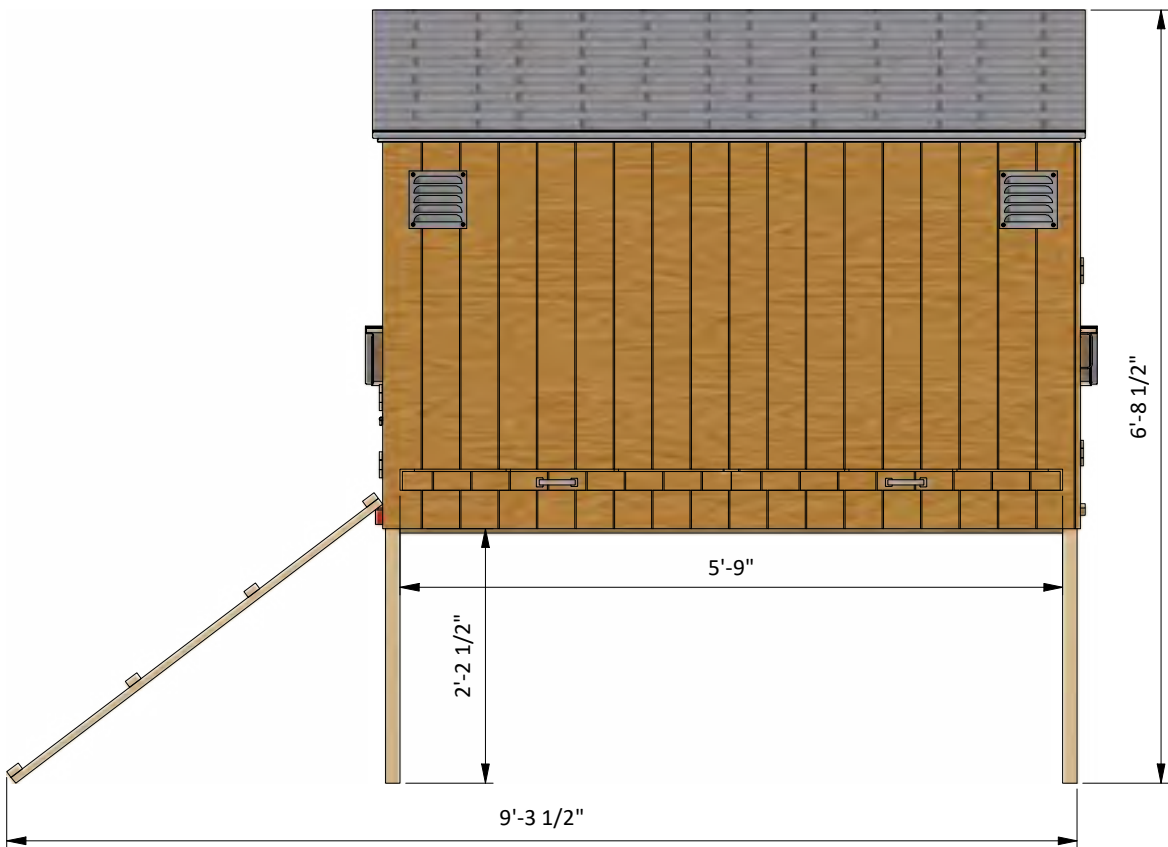
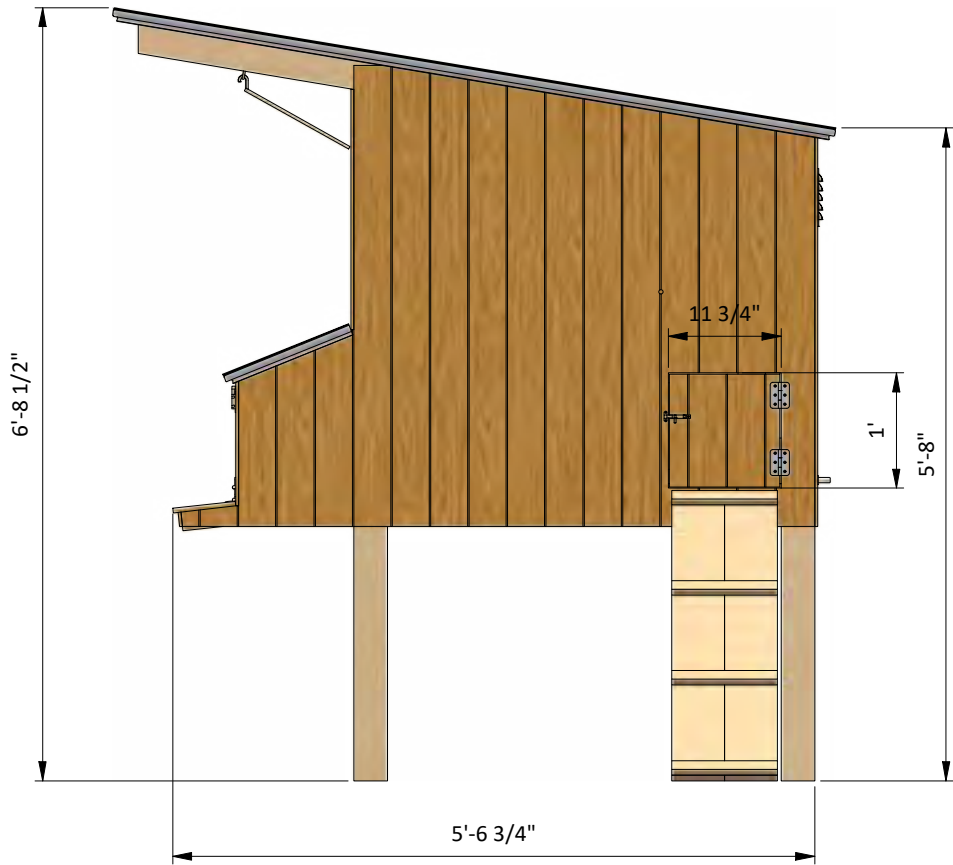

# Interior view

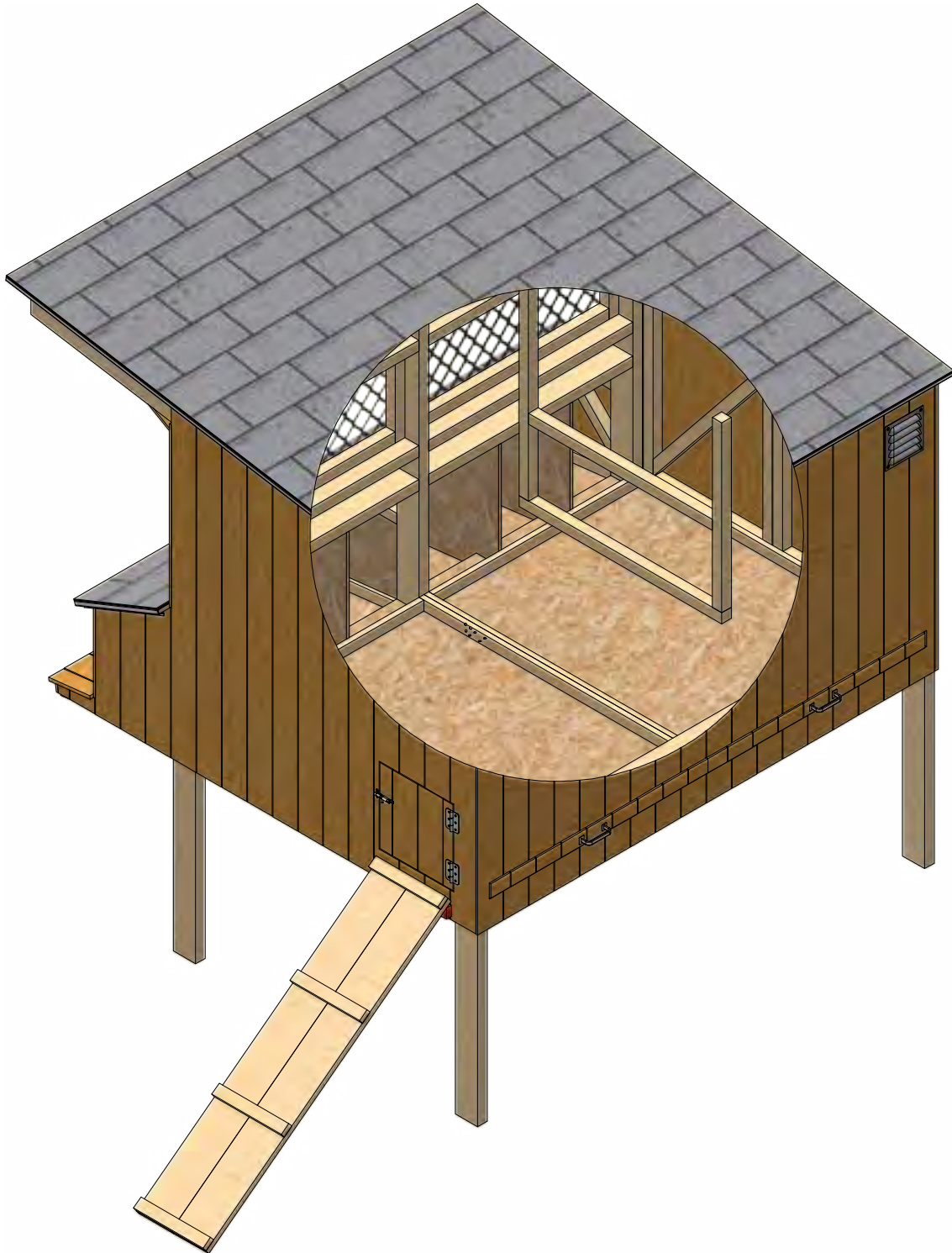

## STEP 1

### Assemble the Coop's Left Wall Frame

1.1 Using 2x4 lumber, assemble the frame using the drawing below as a reference. You will need to prepare beams in necessary quantity according to the cutting list below. Provide cuttings for half lap connection.

1.2 Secure the beams with 1" and 5" wood screws.

Pos	Description	Material	Dimension	Qty
A	Stud	2x4	5'-4 1/2"	1
B	Stud	2x4	6'	1
C	Top beam	2x4	4'-1 1/4"	1
D	Bottom beam	2x4	4'	1
E	Door header	2x4	3'-5"	1

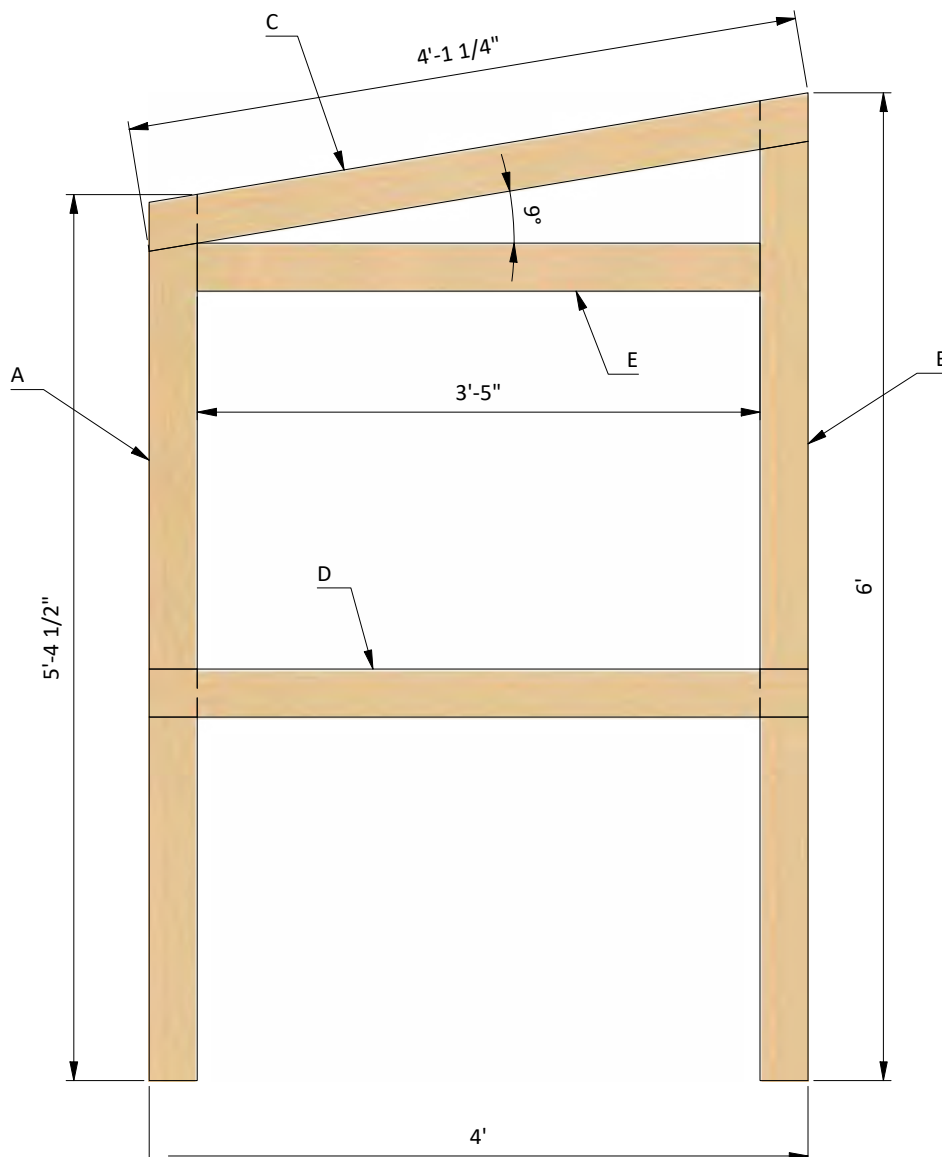

## STEP 2

### Assemble the Coop's Right Wall Frame

**2.1** Using 2x4 lumber, assemble the frame using the drawing below as a reference. You will need to prepare beams in necessary quantity according to the cutting list below. Provide cuttings for half lap connection. Right wall is mirrored to the left wall except the door header.

**2.2** Secure the beams with 1" and 5" wood screws.

Pos	Description	Material	Dimension	Qty
A	Stud	2x4	5'-4 1/2"	1
B	Stud	2x4	6'	1
C	Top beam	2x4	4'-1 1/4"	1
D	Bottom beam	2x4	4'	1

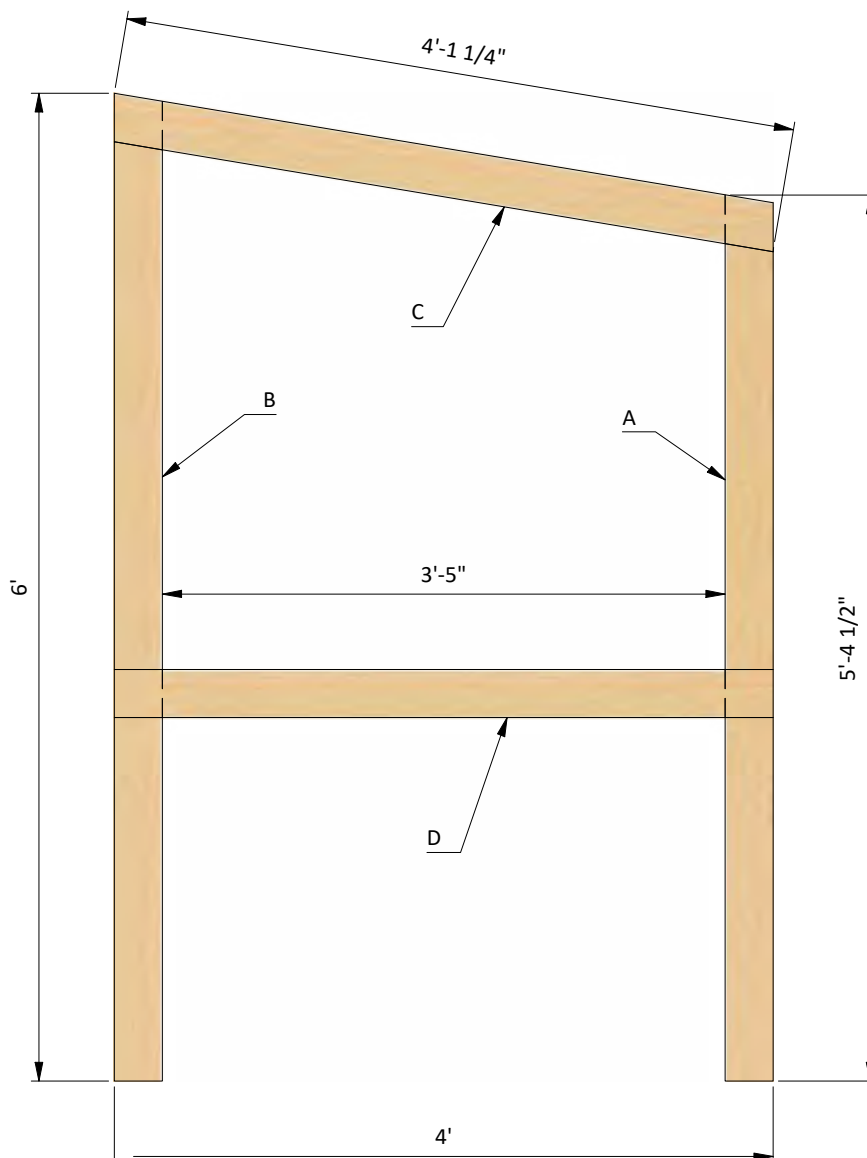

## STEP 3

### Assemble The Floor Frame

**3.1** Using 2x4 lumber, cut joists and assemble using the illustrations below as a reference. You will need to prepare beams in necessary quantity according to the cutting list below.

**3.2** Connect the beams with 3" wood screws.

**3.3** Using a speed square or carpenter's square, check the corners to make sure they are 90°.

Pos	Description	Material	Dimension	Qty
A	Joist	2x4	5'-9"	4

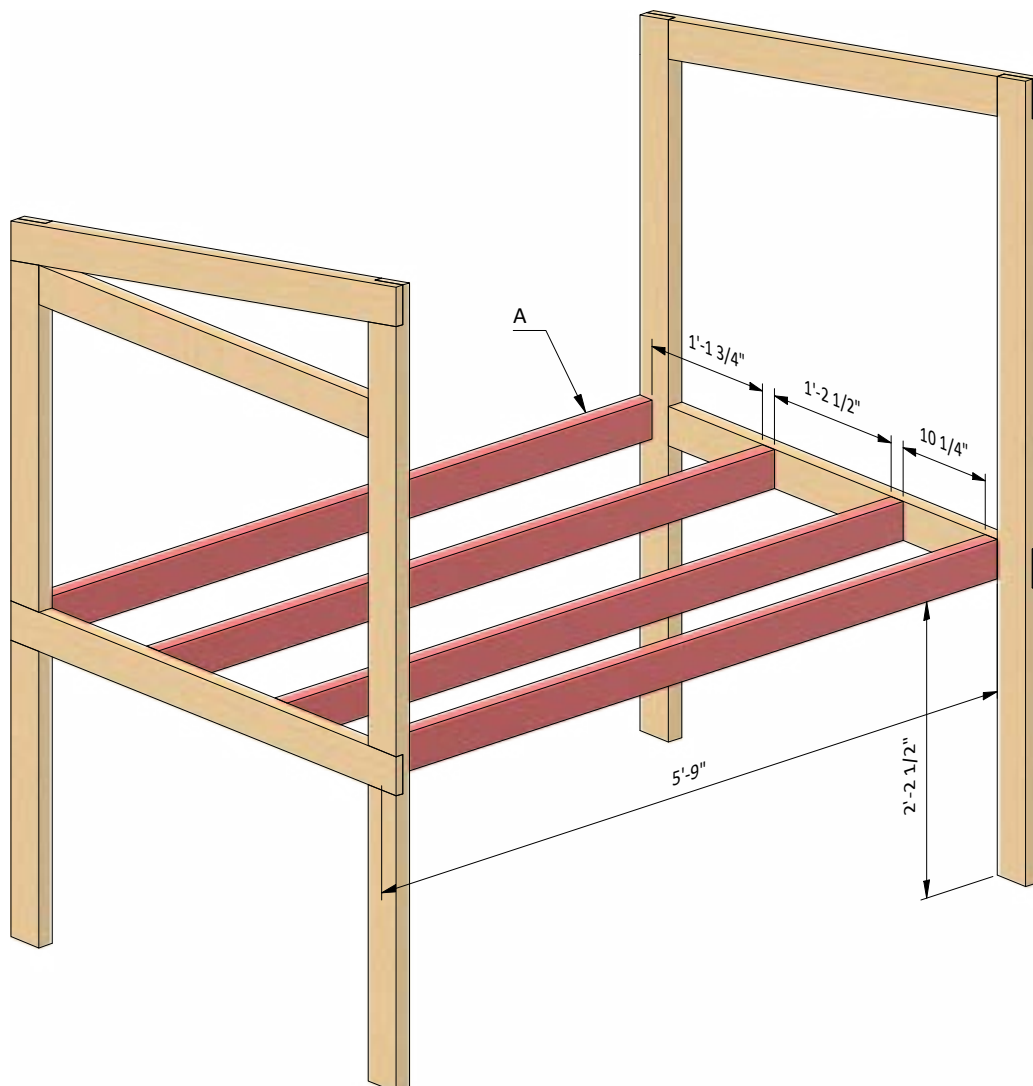

## STEP 4

### Assemble Front Wall Frame

4.1 Using 2x4 lumber, construct wall frame using the drawing below as a reference. You will need to prepare beams according to the cutting list below.

4.2 Connect the beams with 3" wood screws.

4.3 Using a speed square or carpenter's square, check the corners to make sure they are 90°.

Pos	Description	Material	Dimension	Qty
A	Top/Bottom beam	2x4	5'-9"	2
B	Stud	2x4	3'-4 1/2"	3
C	Joist	2x4	2'-10 1/2"	6

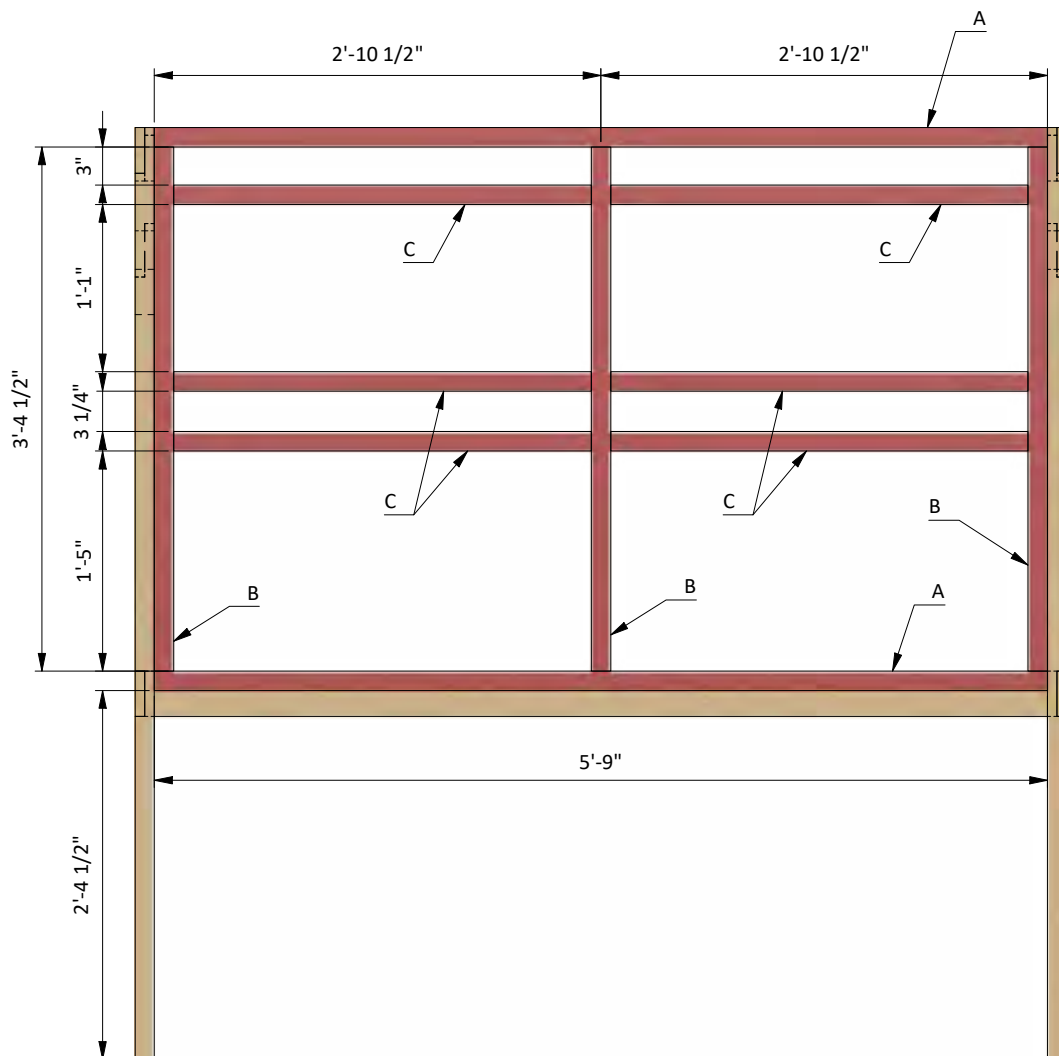

## STEP 5

### Assemble the Coop's Back Wall Frame

5.1 Using 2x4 lumber, assemble the frame using the drawing below as a reference. You will need to prepare beams in necessary quantity according to the cutting list below.

5.2 Secure the beams with 3" wood screws.

5.3 Using a speed square or carpenter's square, check the corners to make sure they are 90°.

Pos	Description	Material	Dimension	Qty
A	Top/Bottom beam	2x4	5'-9"	2
B	Stud	2x4	2'-5"	6

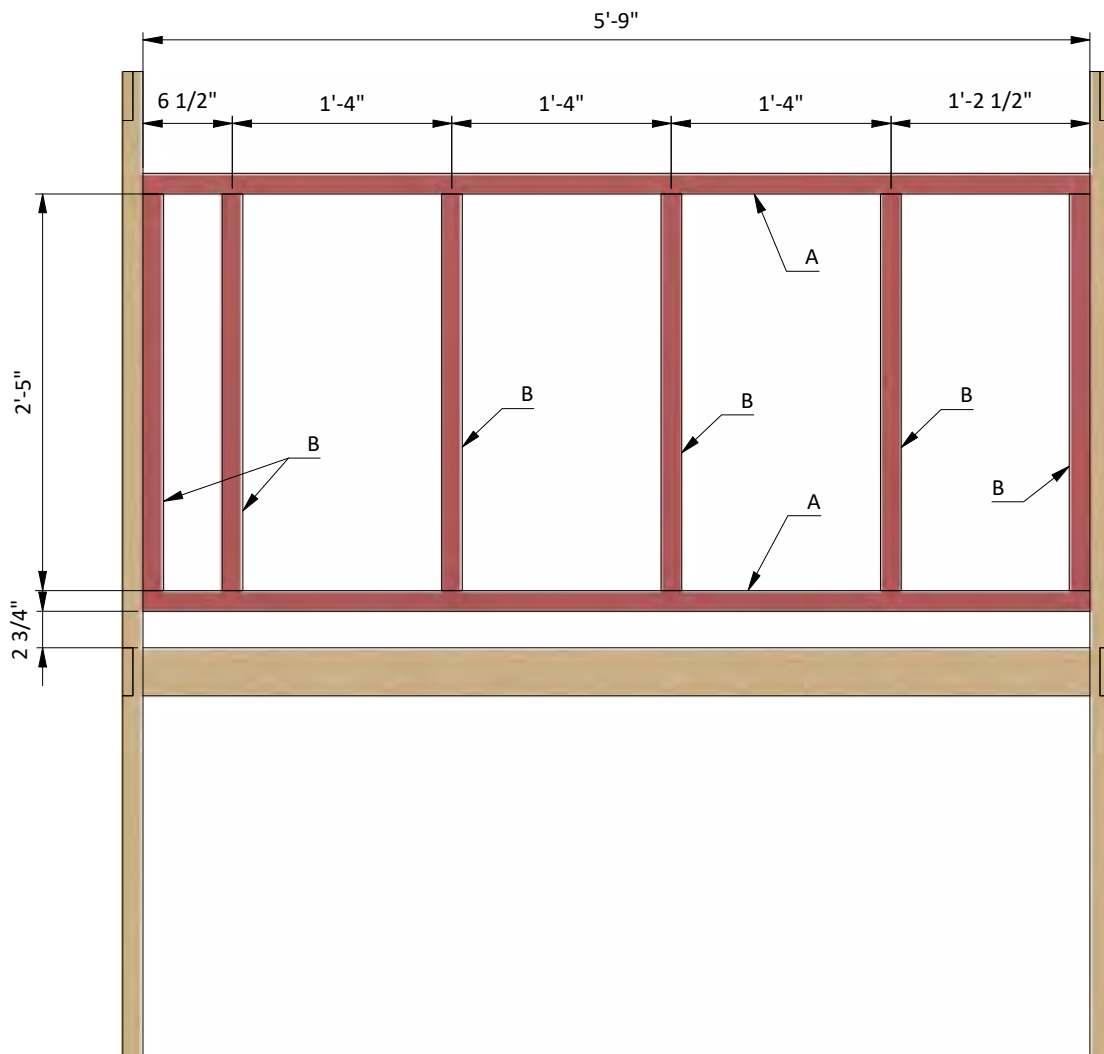

## STEP 6

### Install the Plywood Floor

**6.1** Prepare the 1/2" OSB for the floor sheathing according to the drawing. You will need one 4' x 6' sheet. Cut the corners for the connection with studs.

**6.2** Secure the OSB with 2" wood screws.

Pos	Description	Material	Dimension	Qty
A	Floor sheathing	1/2" OSB	4' x 6'	1

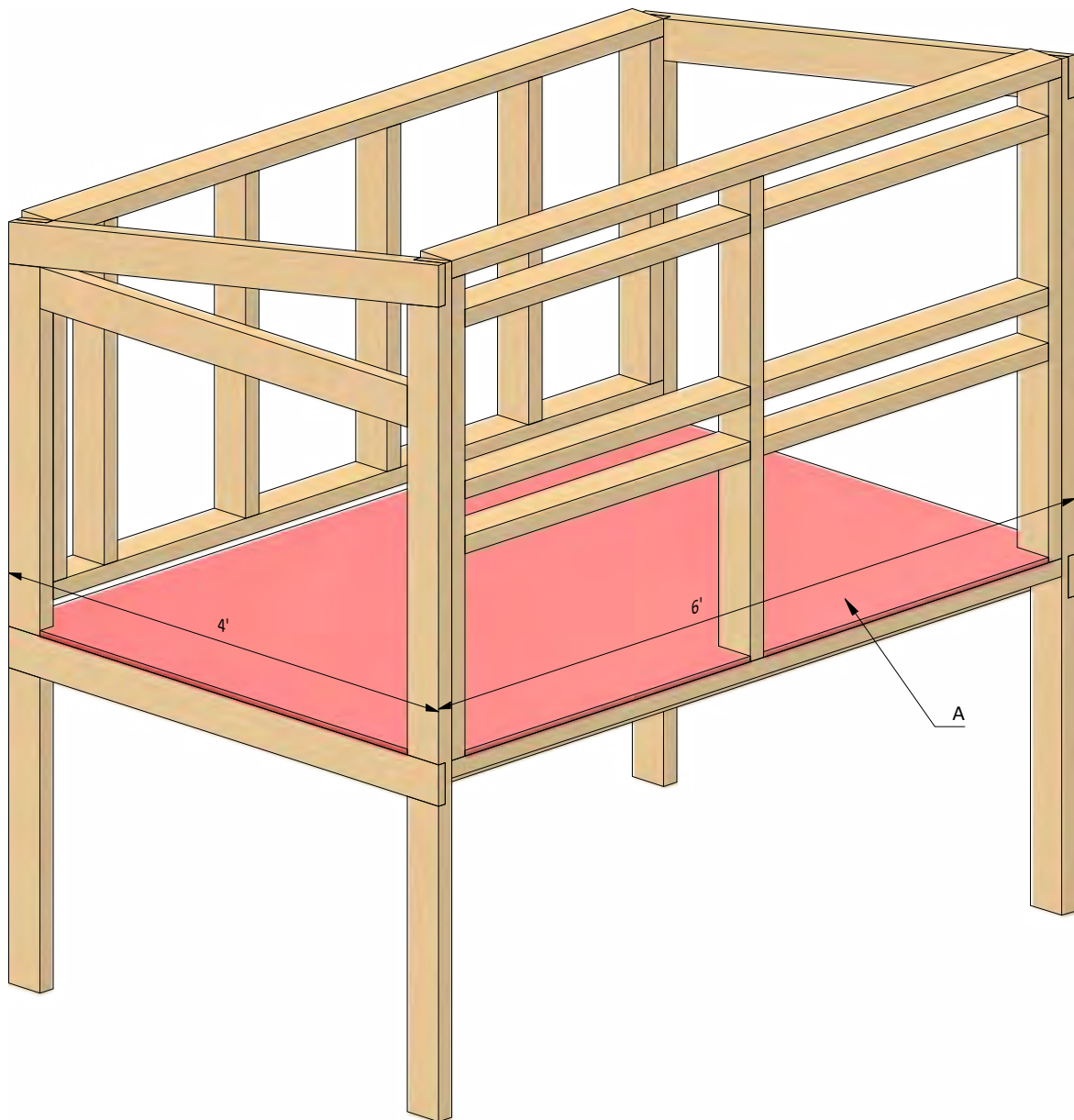

## STEP 7

### Assemble the Roof Frame

7.1 Using 2x4 lumber, construct roof frame using the drawing below as a reference. You will need four boards cut to 6' that will be rafters. Provide cuttings to fit the top beams.

7.2 Connect the rafters with 3" to the top beams.

Pos	Description	Material	Dimension	Qty
A	Rafters	2x4	6'	4

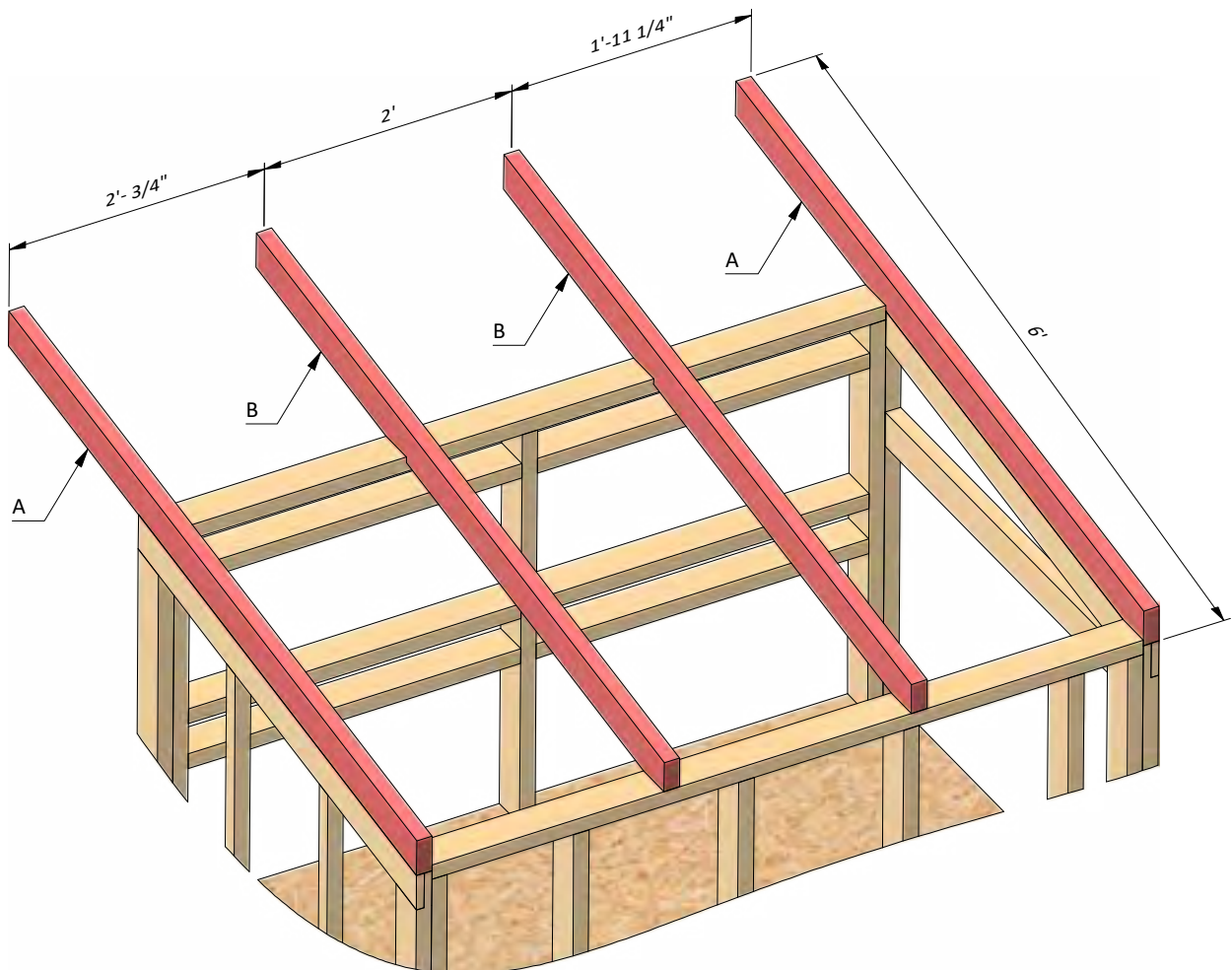



## STEP 9

# Assemble and Install Coop's Front Door

You will need to prepare two mirrored doors

**9.1** Build the door frame using 2x2 lumber. You will need to prepare vertical girts and horizontal girts according to the cutting list below.

**9.2** Prepare one 11/32" plywood siding panel for outer sheathing with dimensions 1'-8 1/4" x 2'-2 3/4" sheet for the door according to the drawing.

**9.3** Install four 2" door hinges using 1" wood screws.  
Finish the door installation by attaching two 6" door pulls.

Pos	Description	Material	Dimension	Qty
A	Girt	2x2	1'-5 1/4"	4
B	Girt	2x2	2'-2 3/4"	4
C	Cross brace	2x2	2'-5 1/2"	2
D	Door sheathing	11/32" plywood	1'-8 1/4" x 2'-2 3/4"	2

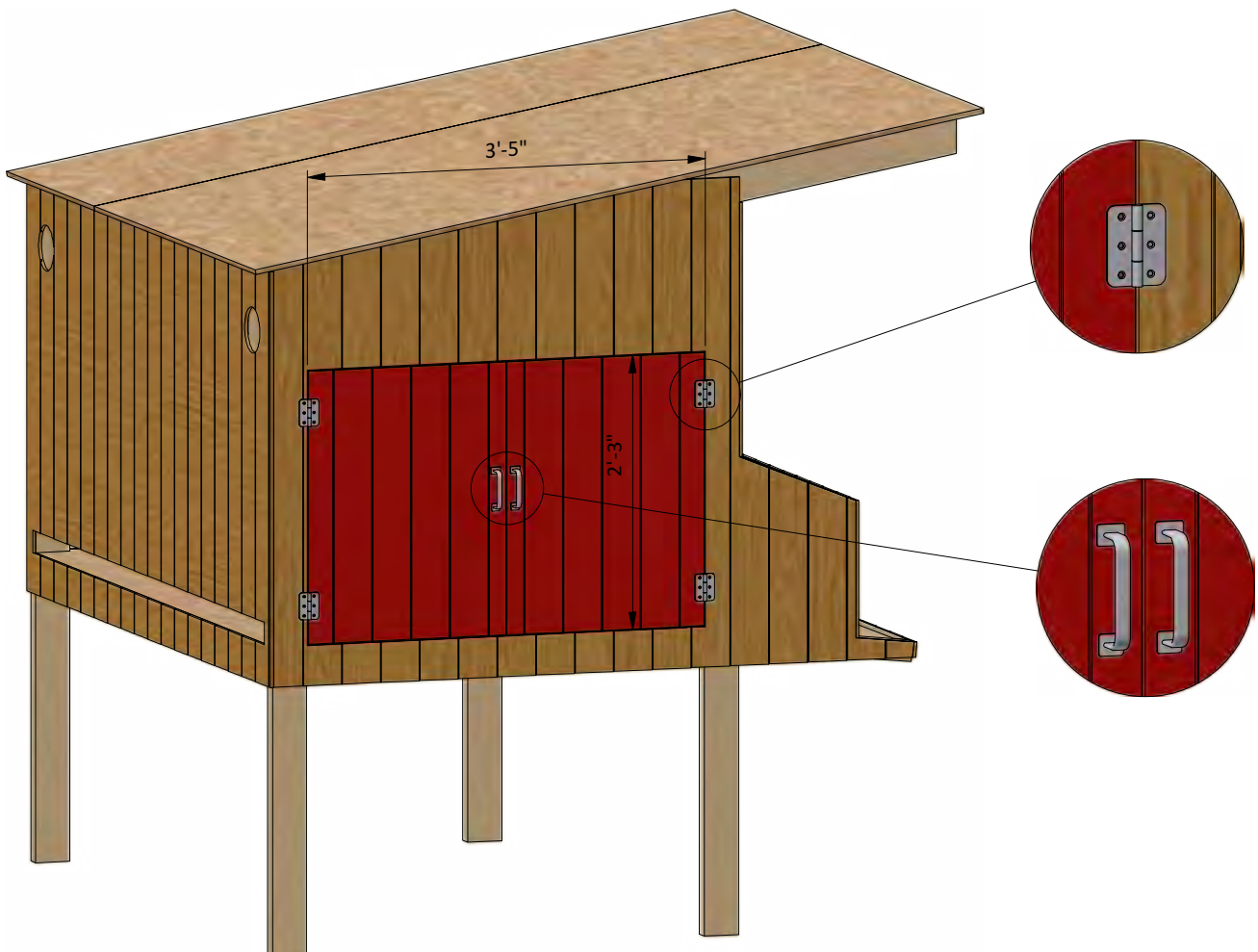

## STEP 10

# Coop's Roof Sheathing Installation

**10.1** Prepare metal drip edge with 6" width. You will need 26' to cover all the perimeter.

**10.2** Place the drip edge down, aligning it to the OSB edge. Use 2" nails to secure the first drip edge. When you place the next drip edge piece, it should overlap the first by an inch.

**10.3** You will need 40 Sq Ft of building paper and asphalt shingle roofing.

**10.4** Cover the OSB and drip edge with building paper. Try to install sheets with 1" overlapping. Use 2" nails to secure the sheets.

**10.5** Install asphalt shingle roofing using an industrial stapler.

Pos	Description	Material	Dimension	Qty
A	Metal drip edge	6"	-	26'
B	Roof sheathing	Building paper	-	40 square ft
C	Roof sheathing	Asphalt shingle roofing	-	40 square ft

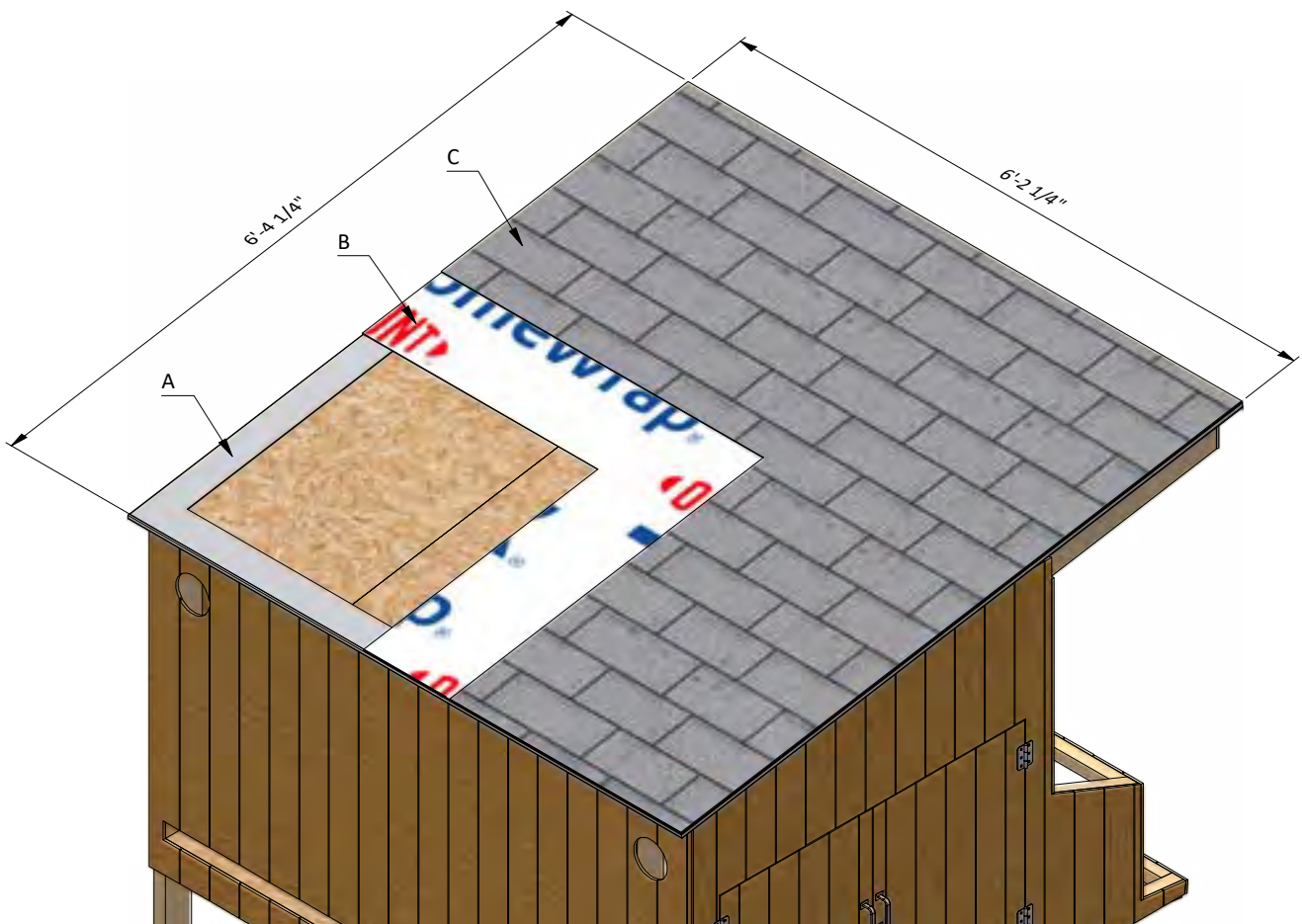

## STEP 11

### Provide and Install Nest Box Doors

You will need to prepare two front doors and two lids for roll out egg case

**11.1** Prepare two 11/32" plywood siding panels with dimensions 10" x 2'-9 1/2" for the front door according to the drawing.

**11.2** Prepare two 11/32" plywood siding panels with dimensions 6 1/2" x 3'-3/4" for the front door according to the drawing.

**11.3** Install eight 2" door hinges using 1" wood screws.  
Finish the door installation by attaching two surface bolts.

Pos	Description	Material	Dimension	Qty
A	Door sheathing	11/32" plywood	10" x 2'-9 1/2"	2
B	Door sheathing	11/32" plywood	6 1/2" x 3'-3/4"	2

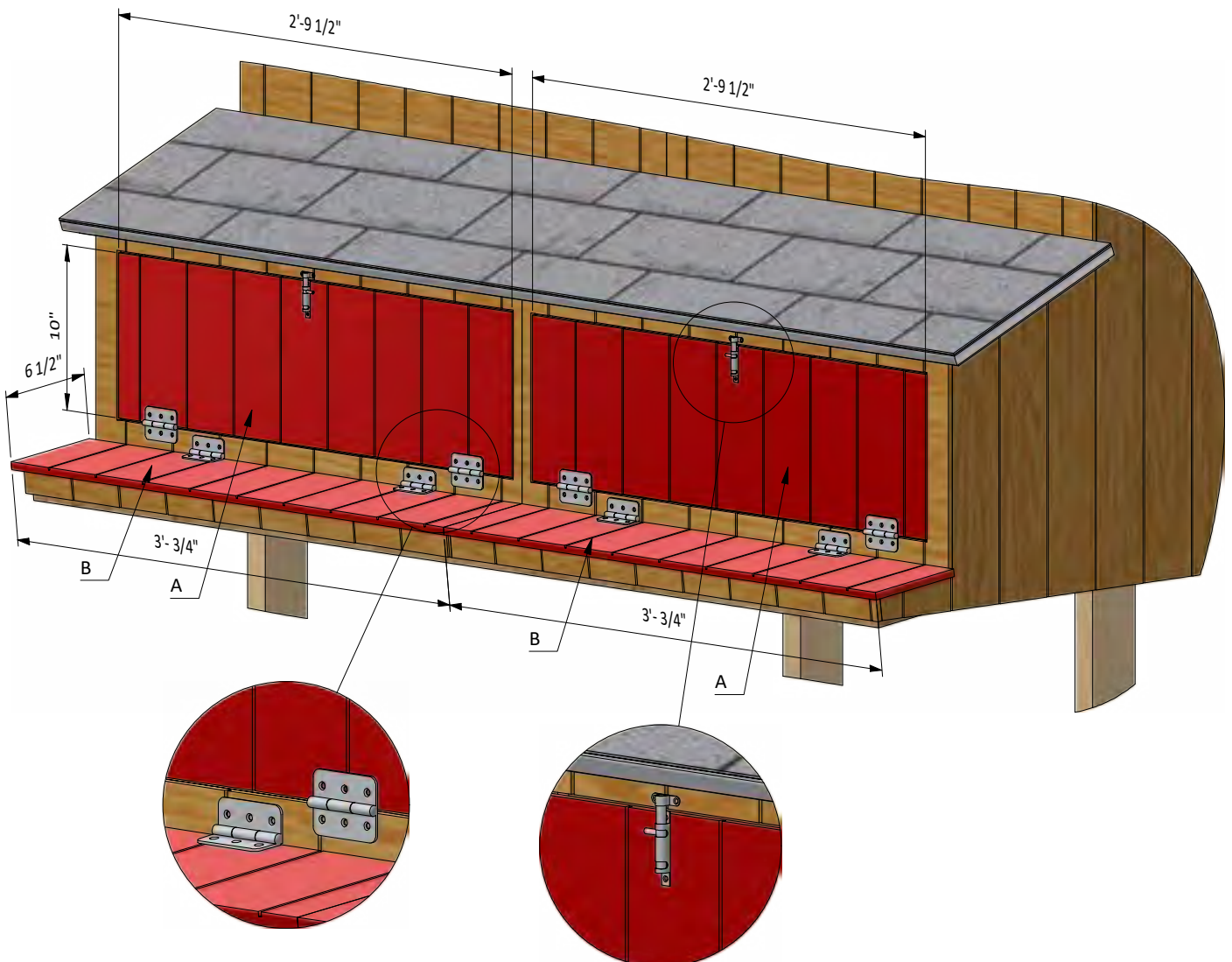

## STEP 12

### Provide and Install Chicken Door

**12.1** Prepare 11/32" plywood siding panel with dimensions 11 1/2" x 11 3/4" for the chicken door according to the drawing.

**12.2** Install two 2" door hinges using 1" wood screws.  
Finish the door installation by attaching two surface bolts.

Pos	Description	Material	Dimension	Qty
A	Door sheathing	11/32" plywood	11 1/2" x 11 3/4"	1

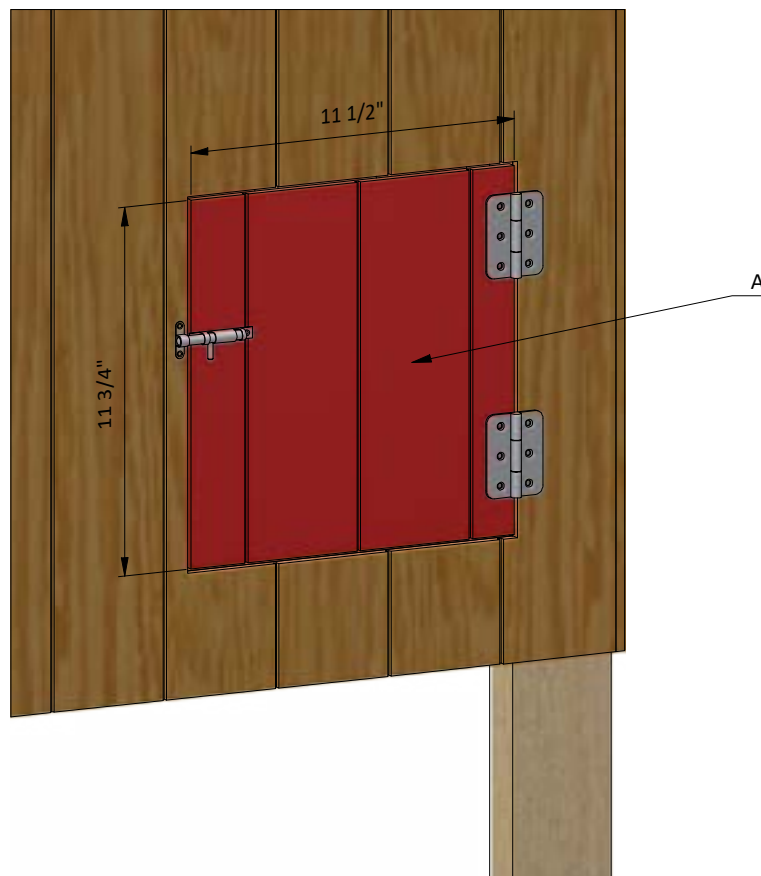

## STEP 13

# Assemble The Chicken Ladder

**13.1** Assemble the ladder using 1x2 and 1x6 lumber. You will need two boards cut to 4' and four beams cut to 11".

**13.2** Connect the beams with 2" wood screws.

**13.3** Attach one more 11" to the wall as support.

Pos	Description	Material	Dimension	Qty
A	Girt	1x6	4'	2
B	Girt	1x2	11"	5

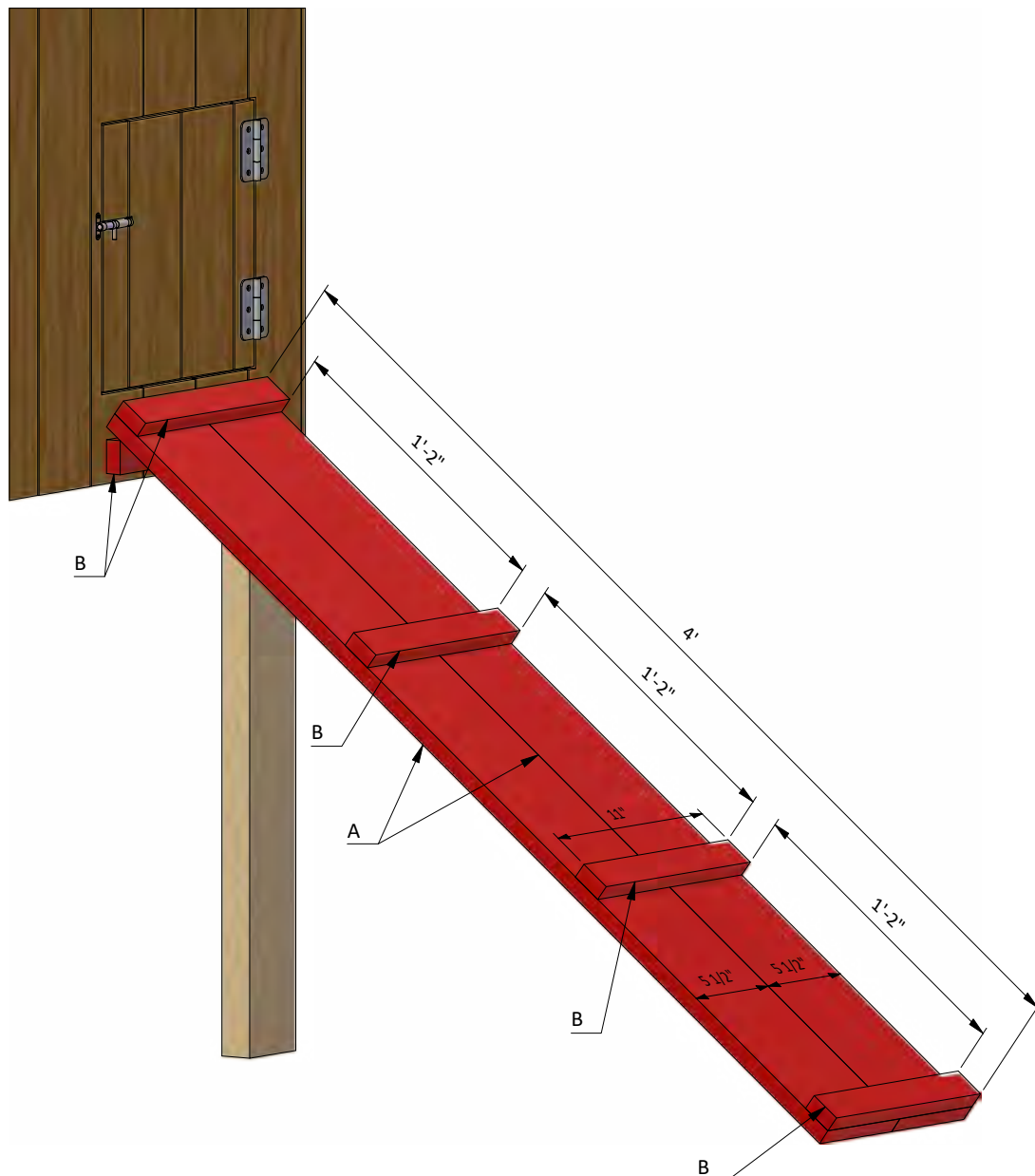

## STEP 14

### Assemble The Litter Tray

**14.1** Assemble the litter tray using 1x2 lumber, 1/2" OSB and 11/32" plywood siding. You will need to prepare four boards for the frame. Assemble the frame and put one sheet of OSB at the bottom. Finish the tray installation by attaching 11/32" plywood siding on the front side and two 6" doorhandles.

**14.2** Connect the beams and plywood with 1" and 2" wood screws.

Pos	Description	Material	Dimension	Qty
A	Girt	1x2	3'-8 1/2"	4
B	Girt	1x2	2'-8 3/4"	4
C	Front sheathing	11/32" plywood	2" x 2'-10 1/4"	2
D	Bottom sheathing	1/2" OSB	2'-10 1/4" x 3'-8 1/2"	2

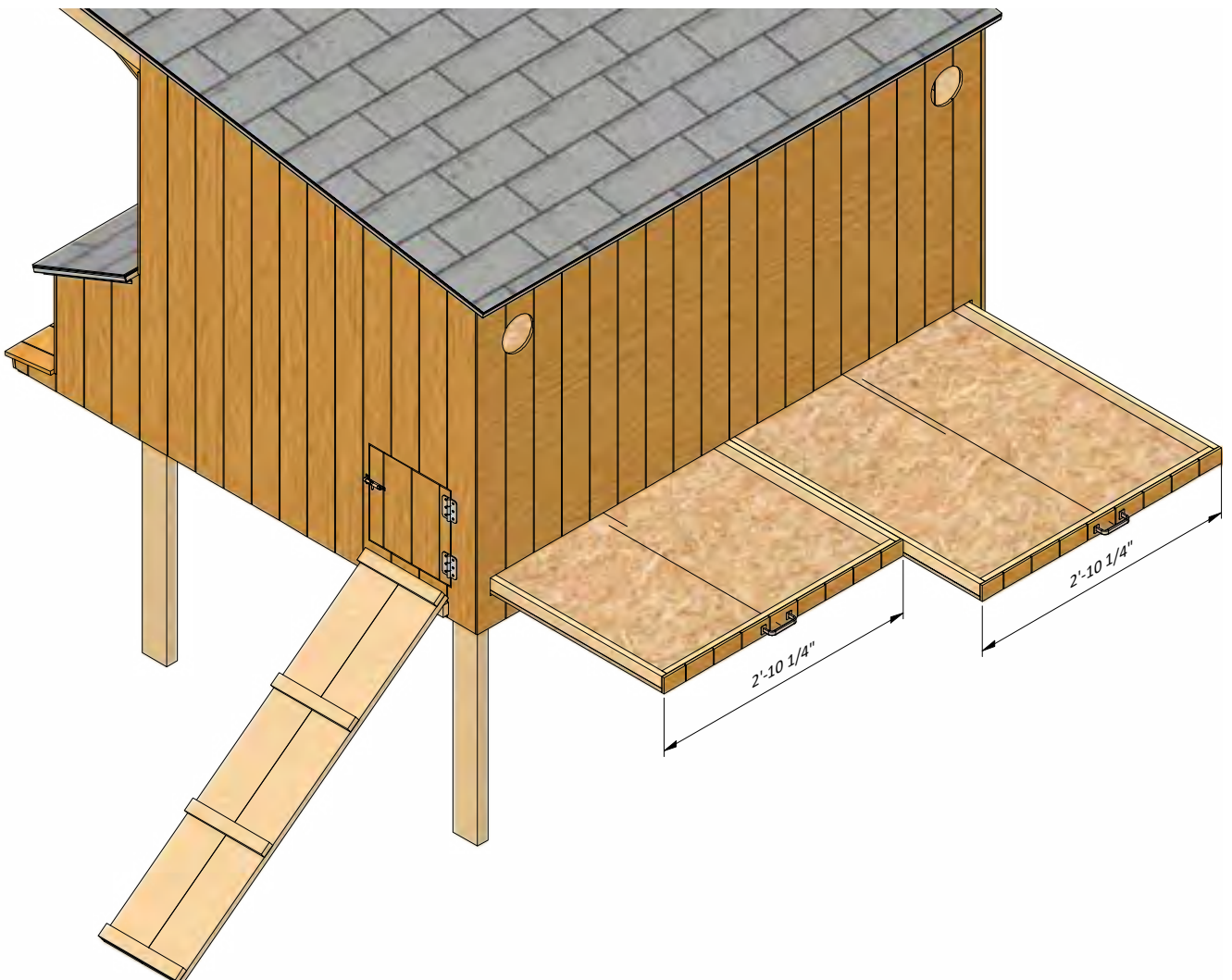

## STEP 15

# Assemble The Roost

**15.1** Assemble the roost using 2x2 lumber.

You will need two boards cut to 2'-6" and two boards cut to 3'-9 3/4".

**15.2** Connect the beams with 2" wood screws.

**15.3** Install the roost to the walls and rafter with the help of 1" nylon belt. Fix the belt with 1/2" nails or staples. Drill the hole in the right wall and insert 5" metal stud for the roost supporting. Due to this construction you can lower the roost vertically to gain access to the interior space.

Pos	Description	Material	Dimension	Qty
A	Girt	2x2	2'-6"	2
B	Stair	2x2	3'-9 3/4"	2

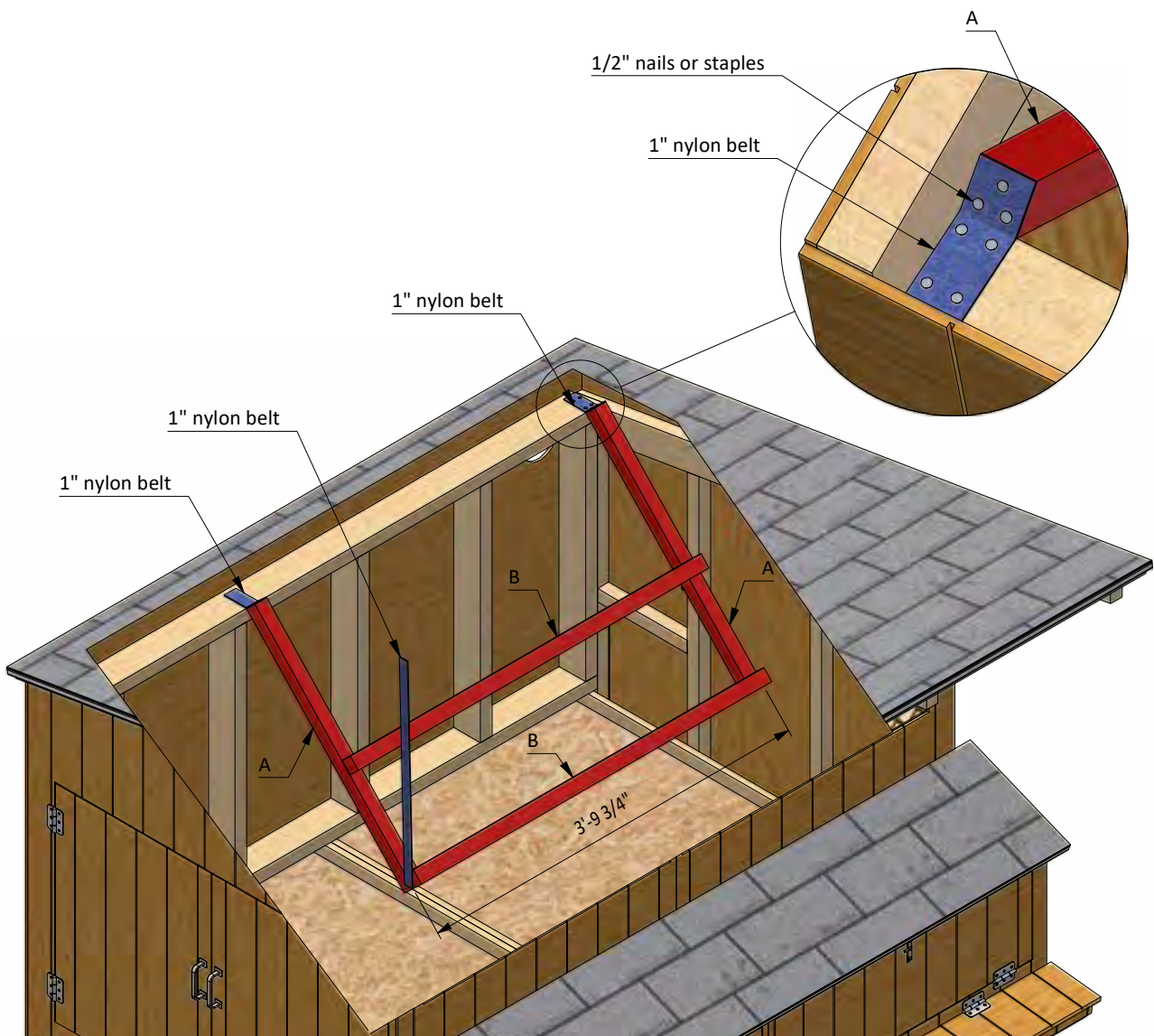

## STEP 16

### Install the Ventilation Louver

**16.1** Fix the louvers to the back wall with 1" screws, completely overlaying the openings.

Pos	Description	Material	Dimension	Qty
A	Ventilation louver	26 Gauge galvanized steel	6" x 6"	2



## STEP 17

### Final Touches

Now that your chicken coop is all done, you are ready to decorate it any way you want using your favorite paint, stain, or preservative.





## Compare Free vs. Premium plan

	Free plan	Premium edition
Pages	17	24
Illustrations for Each Step	✓	✓
Print Ready	✓	✓
Step By Step Instructions	✓	✓
Full Materials and Cuttings List	✗	✓
Additional Illustrations	✗	✓
Additional Blueprints	✗	✓
Tools List	✗	✓
Fastening Elements List	✗	✓
Technical Support	✗	✓

[TRY PREMIUM](#)



For more great **HOW-TO** plans please visit: <https://easycoops.com/>

## Copyright

The text and illustrations that appear here are the exclusive property of shedplans.org and are protected by federal copyright laws. The duplication, sale or distribution of any portion of these plans without prior written consent from the original designer will be subject to the appropriate penalties for copyright infringement. Sharing this plan on the web is only permitted with an indicated original source: <https://easycoops.com/>